

Assembly Instructions

Ginger Twin Loft Bunk Bed

N&D 0109

SAFETY WARNING

1. Follow the information on the warnings appearing on the upper bunk end structure and on the carton. Do not remove warning label from bed.
2. Always use the recommended size mattress or mattress support, or both, to help prevent the likelihood of entrapment or falls.
3. Surface of mattress must be at least 5 in. (127 mm) below the upper edge of guardrails.
4. Do not allow children under 6 years of age to use the upper bunk.
5. Periodically check and ensure that the guardrail, ladder, and other components are in their proper position, free from damage, and that all connectors are tight.
6. Do not allow horseplay on or under the bed and prohibit jumping on the bed.
7. Always use the ladder for entering and leaving the upper bunk.
8. Do not use substitute parts. Contact the manufacturer or dealer for replacement parts.
9. Use of a night light may provide added safety precaution for a child using the upper bunk.
10. Always use guardrails on both long sides of the upper bunk. If the bunk bed will be placed next to the wall, the guardrail that runs the full length of the bed should be placed against the wall to prevent entrapment between the bed and wall.
11. The use of water or sleep flotation mattresses is prohibited.
12. **STRANGULATION HAZARD**—Never attach or hang items to any part of the bunk bed that are not designed for use with the bed; for example, but not limited to, hooks, belts and jump ropes.
13. Keep these instructions for future reference.

SIZE OF MATTRESS AND FOUNDATION:

Use only mattress, which is 37 1/2" - 38 1/2" width and 74"-75" long on upper bunk (twin size.) Ensure that the thickness of the mattress does not exceed 6" and that the mattress surface is at least 5" (127mm) below upper edge of guardrails.

Replacement Parts:

Replacement parts, including additional guardrails may be obtained from any [Night & Day Furniture Dealer](#).

Certified:

This bunk bed conforms to all applicable consumer product safety standards 16 CFR PARTS 1213, 1500, 1513 and ASTM F-1427

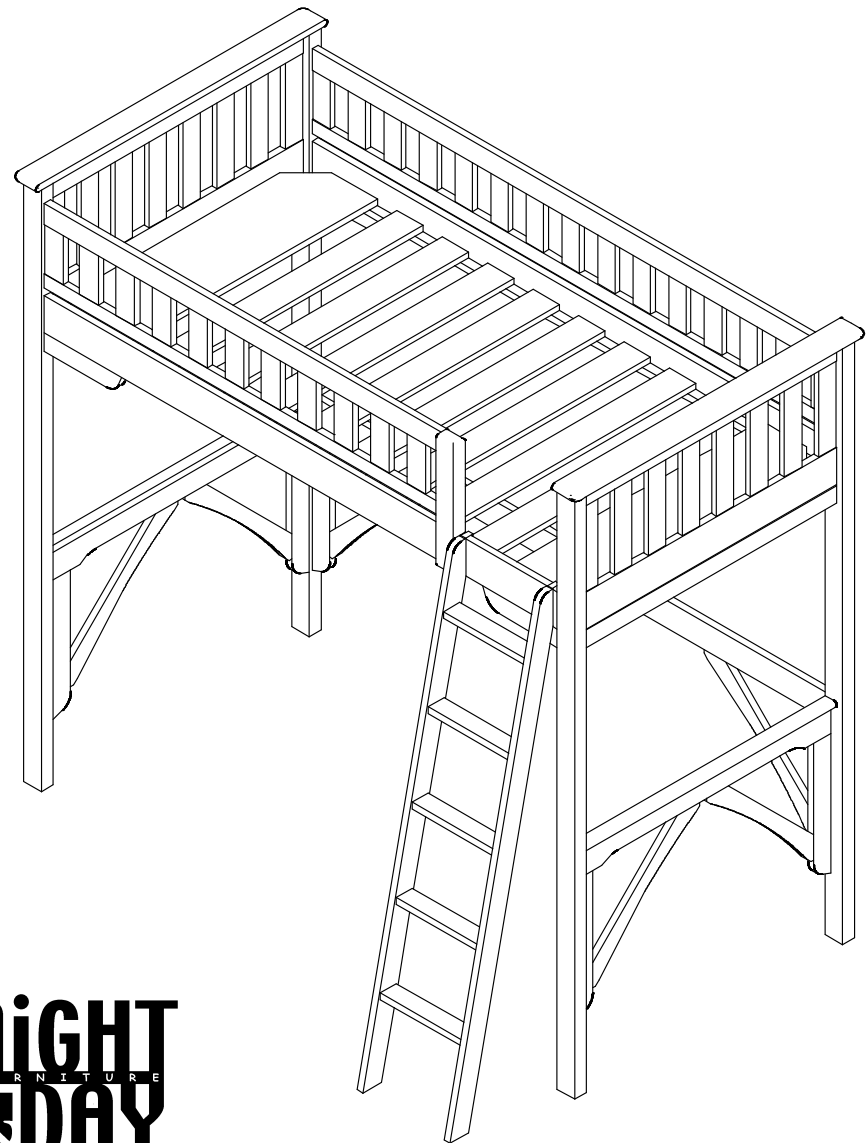

NIGHT
FURNITURE
DAY™

Assembly Instructions

Ginger Twin Loft Bunk Bed

N&D 0109

1A Parts in Box 1

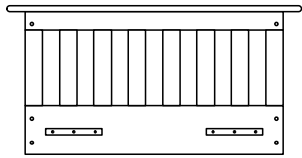

Upper End Frame **x 2**

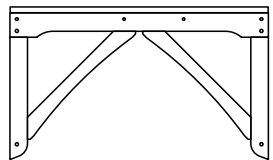

Lower End Frame
(Left Hand) **x 1**

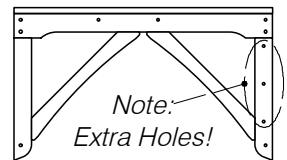

Lower End Frame
(Right Hand) **x 1**

Parts in Box 4

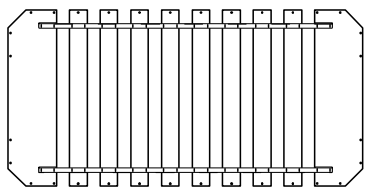

Set of Slats **x 1**

Parts in Box 2

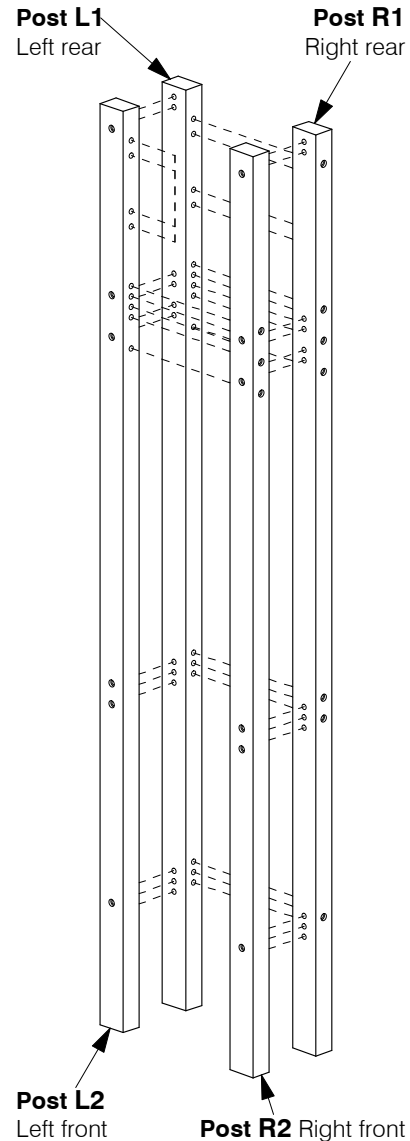

Parts in Box 3



Long Frame **x 1**



Stretcher **x 1**

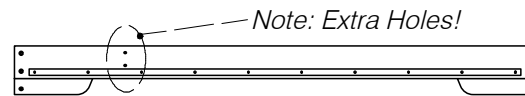

Front Stretcher
(with extra holes) **x 1**

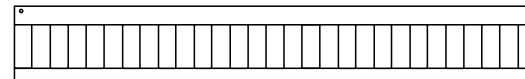

Rear Guard Rail **x 1**

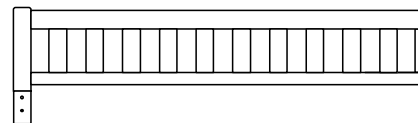

Front Guard Rail **x 1**

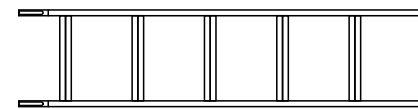

Ladder **x 1**

1B Hardware in this Box.



100mm Bolts
x 21



80mm Bolts
x 24

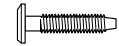

30mm Bolts
x 2

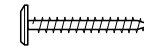

40mm Threaded
Wood Bolts **x 16**



16mm Wood
Screws **x 2**

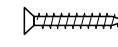

30mm Wood
Screws **x 16**



Wood Dowels
x 47



Barrel Nuts
x 45



Long Allen Key
x 1

Note:

Tools required for assembly:

- Allen Key (provided)
- Philips Screwdriver (not provided)

Assembly Instructions

Ginger Twin Loft Bunk Bed

N&D 0109

2A Assemble the Rear parts: Rear Guard Rail, Stretcher, Long Frame to Posts L1 & R1.

Identify the Posts L1 & R1, as shown below and lay them out on the floor. A carpeted floor is best so as to not damage the wooden parts.

Tap wooden dowels into the dowel holes on the ends of the Rear Guard Rail, Stretcher and Long Frame. Use 100mm Bolts and Barrel Nuts to join them together.

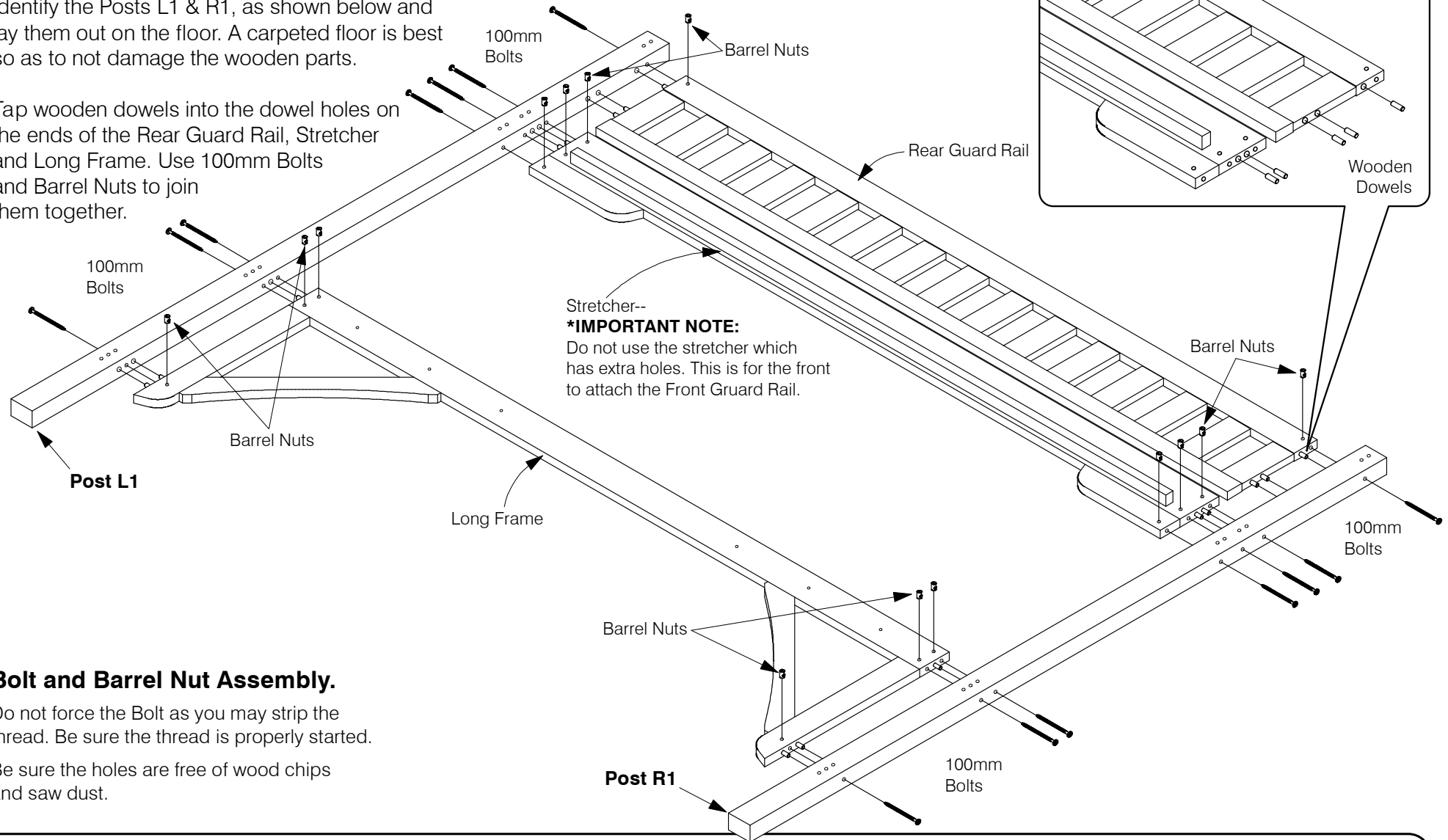

Bolt and Barrel Nut Assembly.

- ✓ Do not force the Bolt as you may strip the thread. Be sure the thread is properly started.
- ✓ Be sure the holes are free of wood chips and saw dust.

Assembly Instructions

Ginger Twin Loft Bunk Bed

N&D 0109

3A Assemble the Left and Right side frames.

Identify the Posts L2 & R2, as shown below and lay them out on the floor, with the end frames. Tap wooden dowels into the dowel holes.

Use 80mm Bolts and Barrel Nuts to join them together.

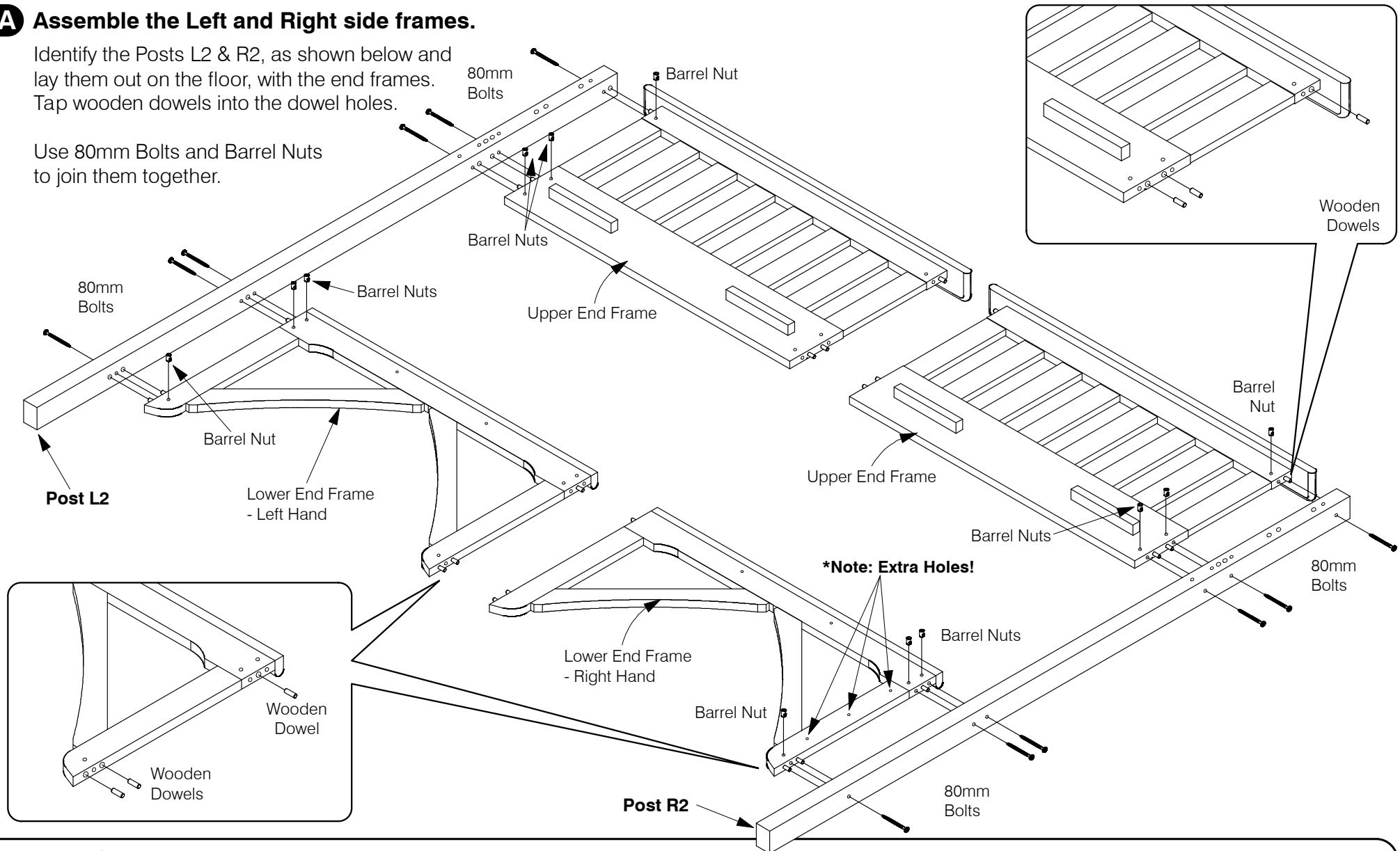

Assembly Instructions

Ginger Twin Loft Bunk Bed

N&D 0109

4A Join the end frames to the Rear posts.

Attach the assembled left hand side to the assembled rear posts using 80mm Bolts and Barrel Nuts.

Then attach the Right hand side.

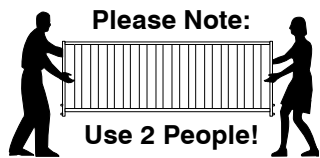
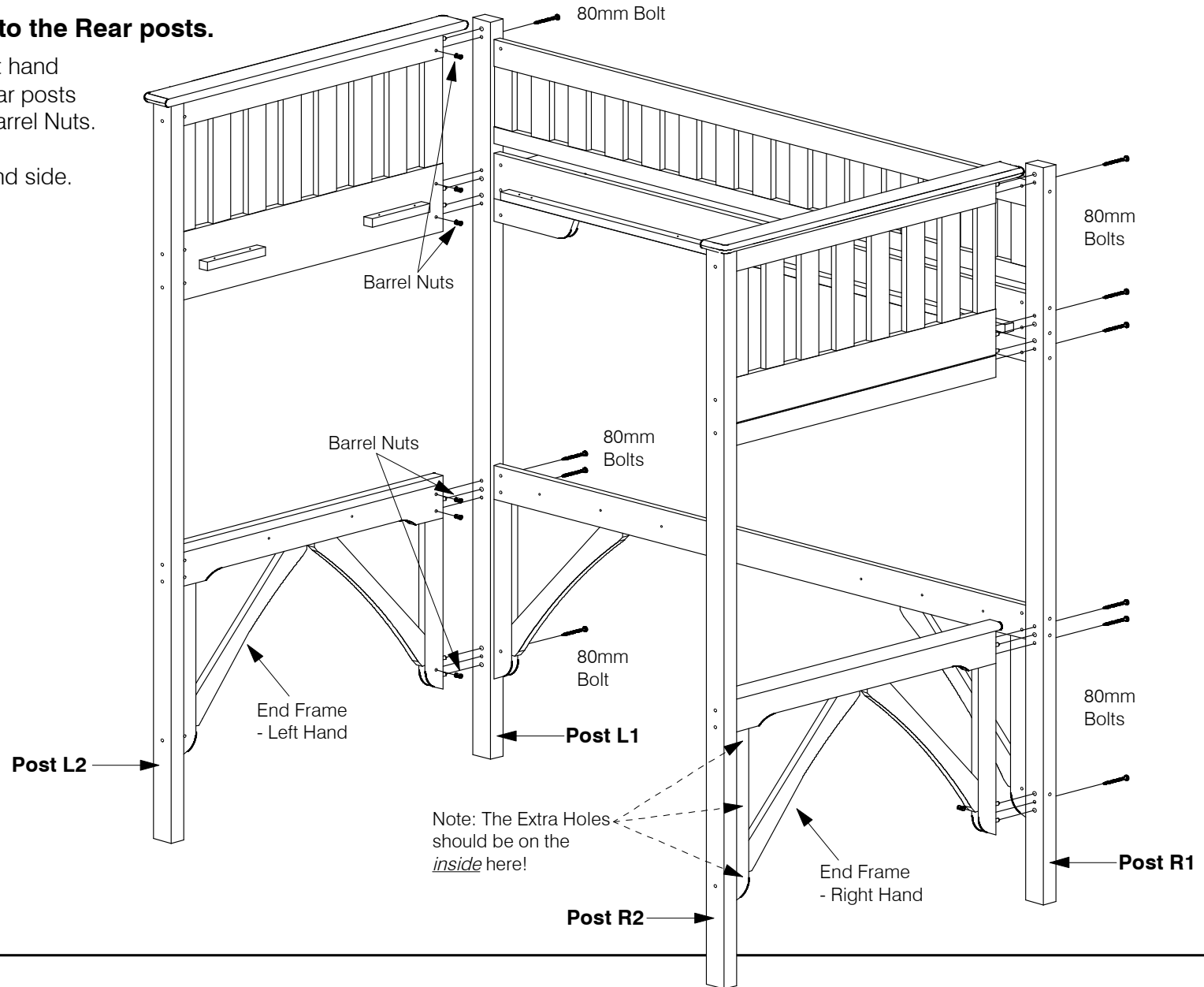

Assembly Instructions

Ginger Twin Loft Bunk Bed

N&D 0109

5A Attach the front stretcher.

Use 100mm Bolts and Barrel Nuts to fit the Front Stretcher between the front posts.

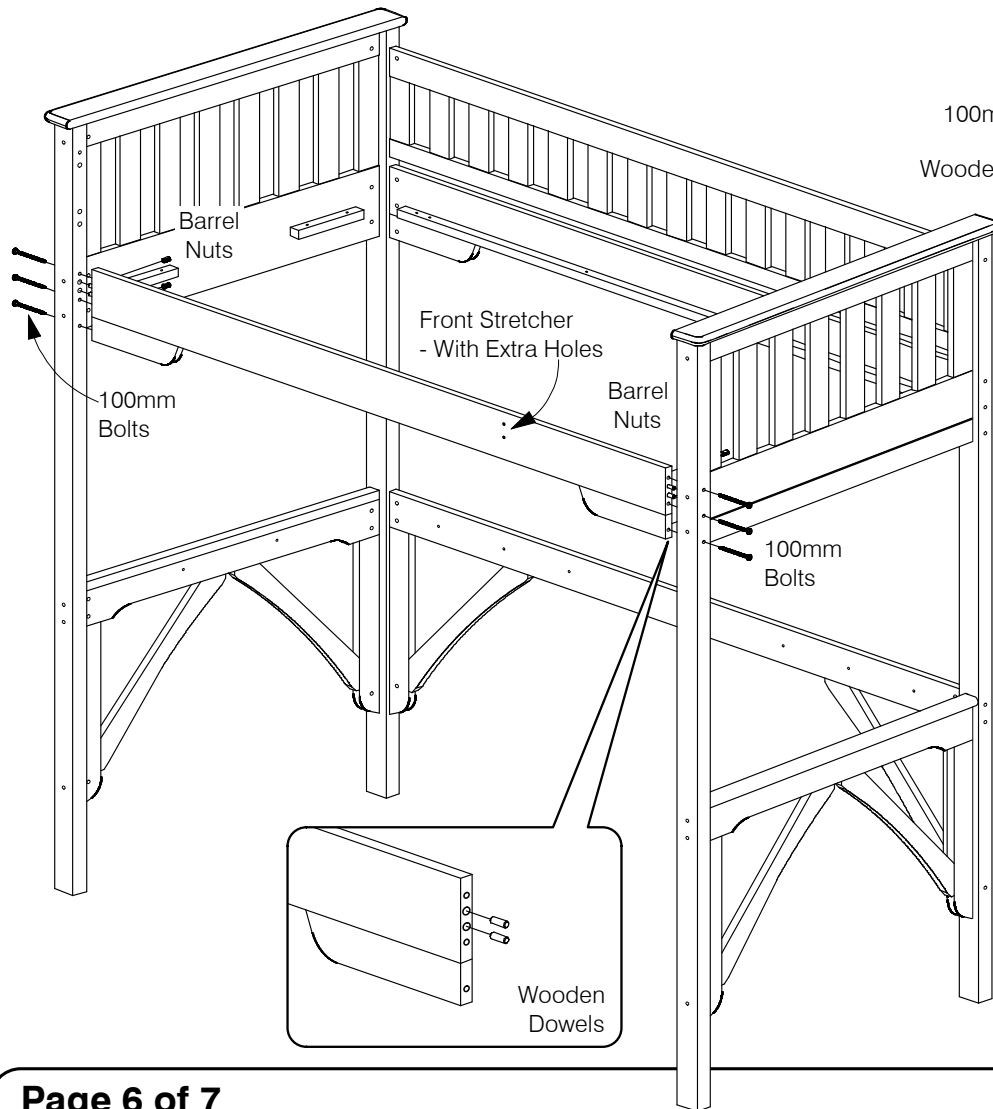

5B Attach the Front Guard Rail.

Tap Wooden Dowels into the end of the Front Guard Rail. Use the 100mm Bolt and Barrel Nut fix it in place. The Front Guard Rail attaches to the Front Stretcher using the 30mm Bolts.

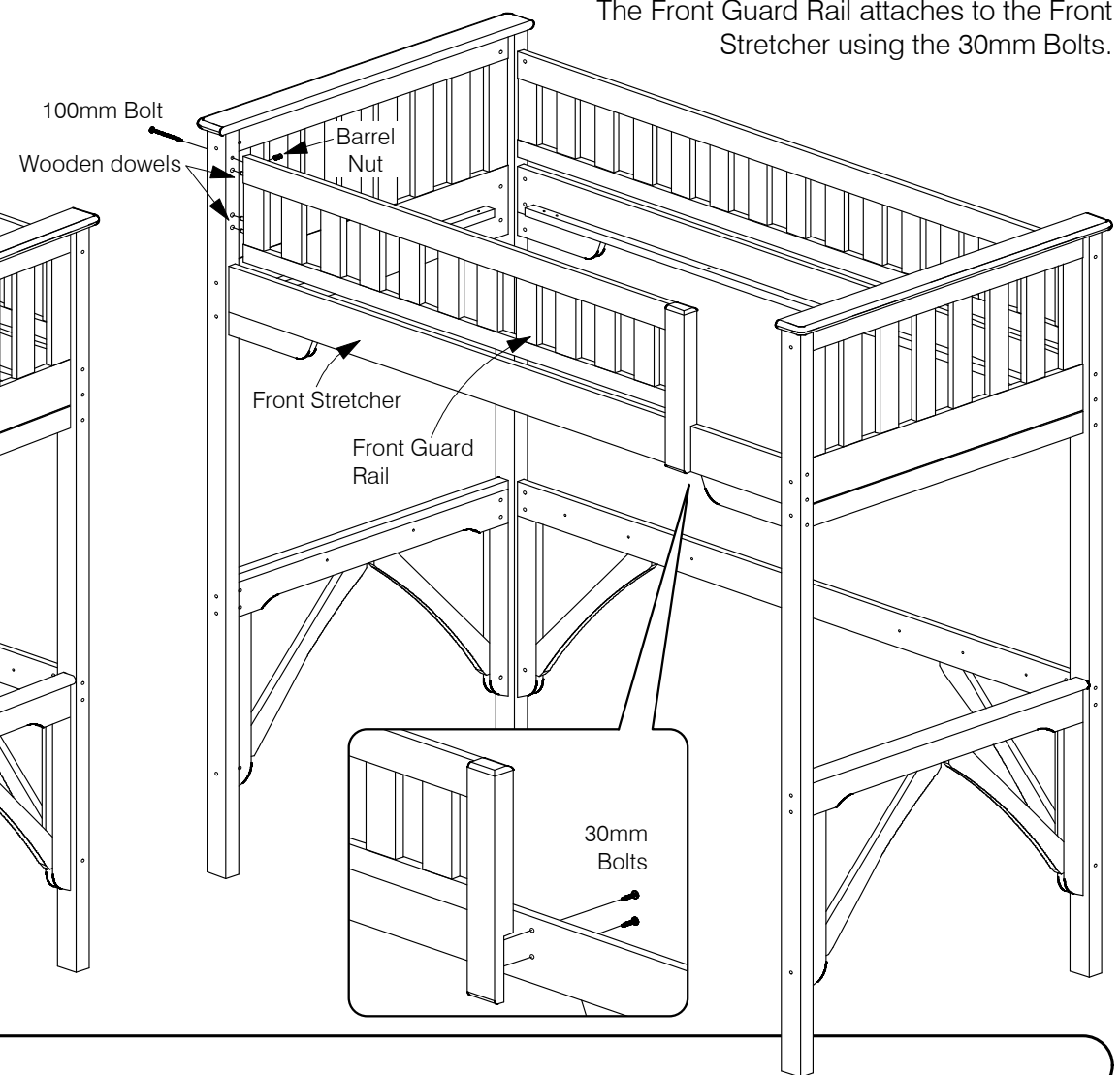

Assembly Instructions

Ginger Twin Loft Bunk Bed

N&D 0109

6A Bolt the Slats to the Stretchers.

Lay the Slats inside the Stretchers as shown below, and Bolt in place with the 40mm Threaded Wood Bolts (total 16 Bolts) and 30mm Wood Screws (total 16 Screws).

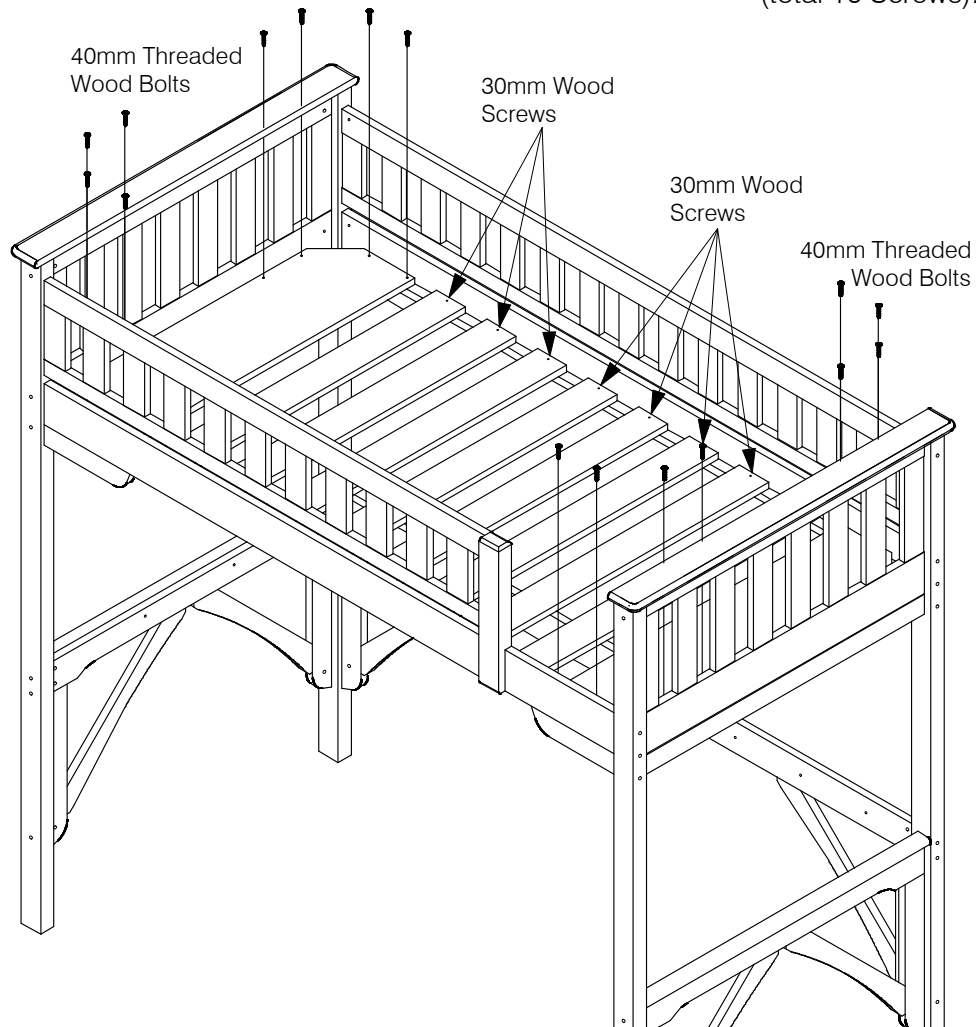

6B Attach the Ladder to the Front Stretcher.

Finally, hook on the Ladder onto the Front Stretcher. Use the 16mm Wood Screws to fix the Ladder in place.

- Please take note of the warnings shown on page one of these instructions, printed on the carton box and on stickers on the Bunk bed.

