

MOE'S

home collection

ASSEMBLY INSTRUCTIONS.





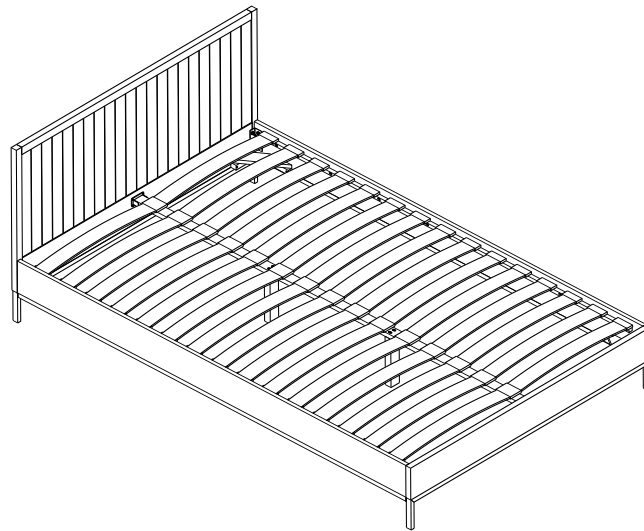











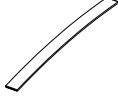

MONTEGO QUEEN BED

YC - 1011 - 24



THANK YOU FOR YOUR PURCHASE!

PARTS AND HARDWARE.

1. Headboard x1 	2. Side rail x 2 	3. Footboard x1 
4. Corner block x4 	5. Middle leg x2 	6. Center beam x1 
7. Double slat clip x15 	8. Single slat clip x 30 	9. Steel pat x 4 
10. Slat wood x 30 	A. F-Bolt M6-25 x 4 	B. Plain washer Ø16 - Ø6.5 x 4 
C. Spring washer Ø10 - Ø6.5 x 4 	D. F-Bolt M8-15 x 16 	E. Plain washer Ø19 - Ø8 x 16 
F. Spring washer Ø12 - Ø8 x 16 	G. F-Bolt M6-30 x20 	H. F-Bolt M6-15 x 2 
I. Wood dowel Ø10 - 30 x 4 	J. Allen key x 2 	

NOTES.

Thank you for purchasing this quality product! Be sure to check all packing material carefully for small part that may have come loose inside the carton during shipping.

CAUTION: The item is heavy, take care when lifting and use 2 people to maneuver safely.

STEP 1.

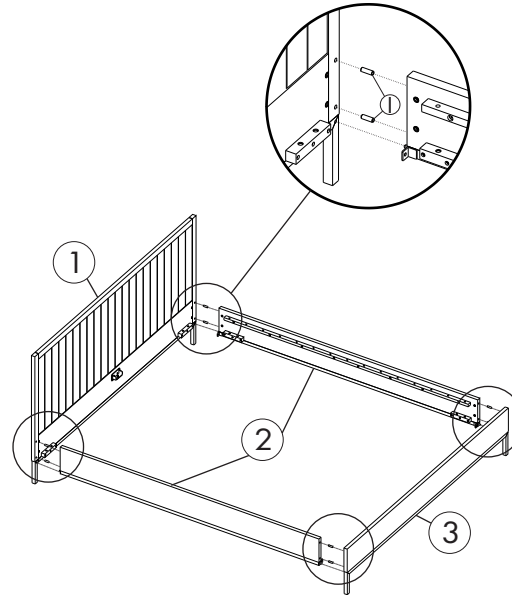

STEP 2.

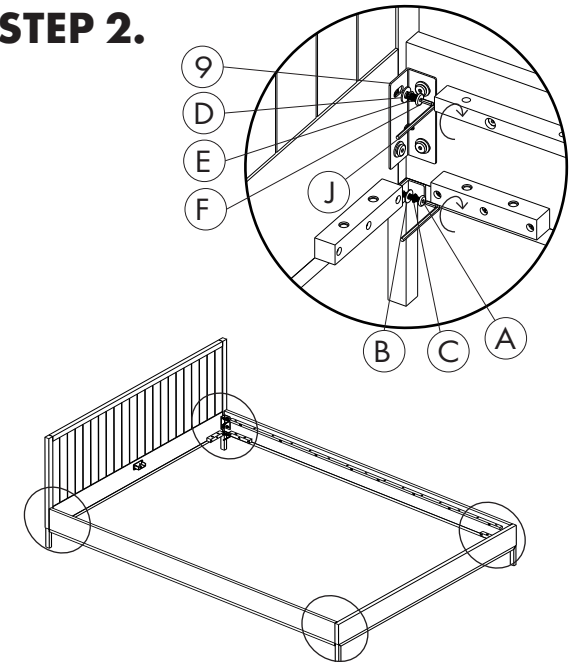



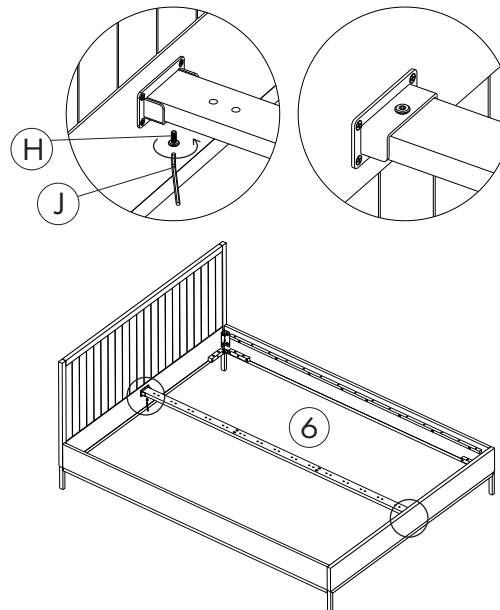



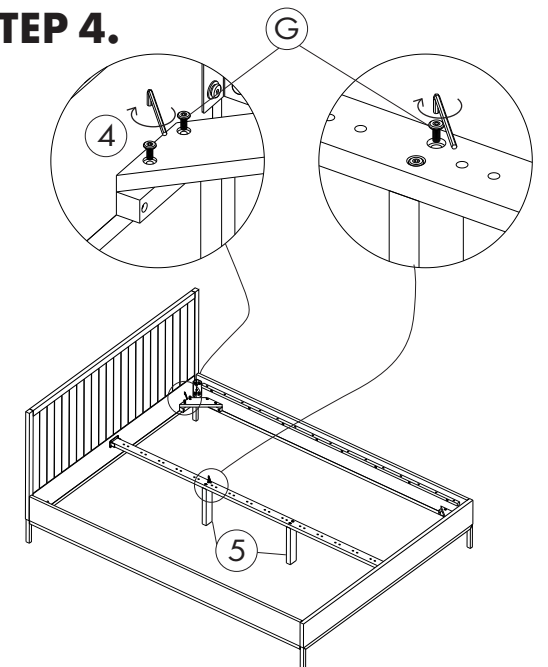









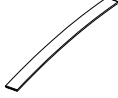

STEP 3.



STEP 4.



PARTS AND HARDWARE.

1. Headboard x1 	2. Side rail x 2 	3. Footboard x1 
4. Corner block x4 	5. Middle leg x2 	6. Center beam x1 
7. Double slat clip x15 	8. Single slat clip x 30 	9. Steel pat x 4 
10. Slat wood x 30 	A. F-Bolt M6-25 x 4 	B. Plain washer Ø16 - Ø6.5 x 4 
C. Spring washer Ø10 - Ø6.5 x 4 	D. F-Bolt M8-15 x 16 	E. Plain washer Ø19 - Ø8 x 16 
F. Spring washer Ø12 - Ø8 x 16 	G. F-Bolt M6-30 x20 	H. F-Bolt M6-15 x 2 
I. Wood dowel Ø10 - 30 x 4 	J. Allen key x 2 	

NOTES.

Thank you for purchasing this quality product! Be sure to check all packing material carefully for small part that may have come loose inside the carton during shipping.

CAUTION: The item is heavy, take care when lifting and use 2 people to maneuver safely.

STEP 5.

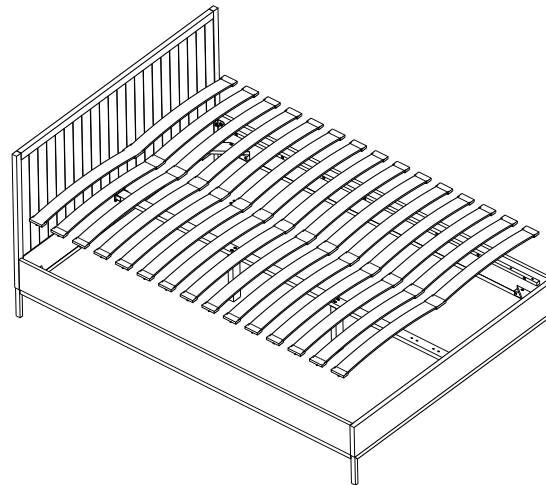
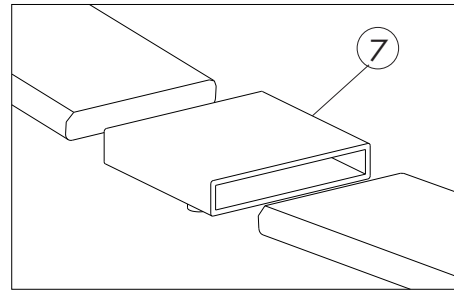
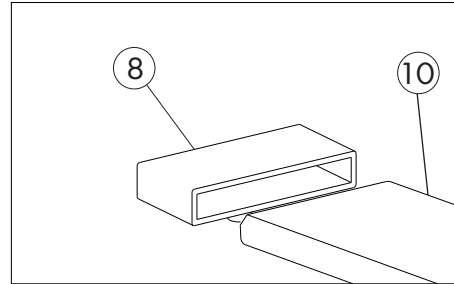

STEP 6.

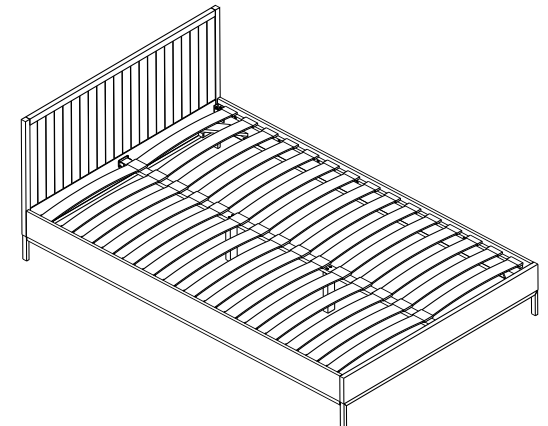

Dear Customer,

Congratulations on your purchase of a piece of furniture made from solid American White Oak.

The individual wood slats in your piece of furniture are especially selected and sorted by hand by skilled craftsmen. They follow specific guidelines securing the quality demands and design preferences that lay out the form of this furniture range. Through this we have manufactured a unique piece of furniture with the heterogeneity that characterizes wild-oak, clearly showing the wood's natural irregularities of strong grains, knots and smaller cracks. Features that are often avoided in other furniture ranges. Twists in the wood, smaller cracks and repairs are parts of the uniqueness of the range, and therefore do not qualify for complaints. Wood is a living material, affected by temperature and moisture for a long period after you start using it. Thereby, table tops and top plates will expand and shrink according to the seasons, and cracks and spaces that vary in time are some of the joys of owning a natural product. If extension leaves are made from mdf, which is a stable material, these will never be able to fit the table by 100 %.

To make sure that you will enjoy many years of satisfaction with your piece of furniture, it is imperative with the right care and maintenance. Kindly follow the below guidelines, and we guarantee that your unit will stay beautiful in the years to come. It is our recommendation that you ask your furniture supplier for advice in any instance. Furthermore, we strongly suggest that you use the furniture oil or soap that is available from your furniture store. The instructions will be stated on the product.

Your piece of furniture is already oil or soap treated from the factory. How often should the piece of furniture be treated with oil?

1. Preferably already before use
2. The surface should be treated when necessary, and we suggest as often as every three months

How do you apply the oil to the piece of furniture?

1. Apply plenty of oil with a clean cloth. Table tops must be treated underneath as well as on the top side. (Do not drop oil on the floor!)
2. After 15 minutes, polish with a sandpaper sponge or fine sandpaper (no. 150) along the grains of the wood
3. Polish off remaining oil with a clean, dry cloth
4. Do not use the item, until the oil is completely absorbed

How do you apply soap to the piece of furniture?

1. Apply the soap material with a clean cloth, starting from one end/side and along the grains of the wood. The piece of furniture does not need water - just soap. Table tops must be treated underneath as well as on the top side
2. After 15-30 minutes, wipe off remaining soap with a clean, dry cloth, and let the surface dry up. If the surface is rough, you can polish with a sandpaper sponge or fine sandpaper (no. 150)

Daily maintenance:

1. Clean the surface with a clean, wrung out cloth. Never use detergents
2. Coloured stains like red wine must be dried off immediately
3. Smaller stains and marks can be polished off with sand paper no. 220 or 180
4. Avoid extreme humidity and heat. Do not place the item close to heat sources
5. Legs for coffee and dining tables must be fastened occasionally
6. Extension leaves in lacquered mdf are not to be treated. Please clean with a wrung out cloth