

48"W McKenzie Alder Bookcases with Doors: 72" + 84"H Finished Program

Assembly Instructions

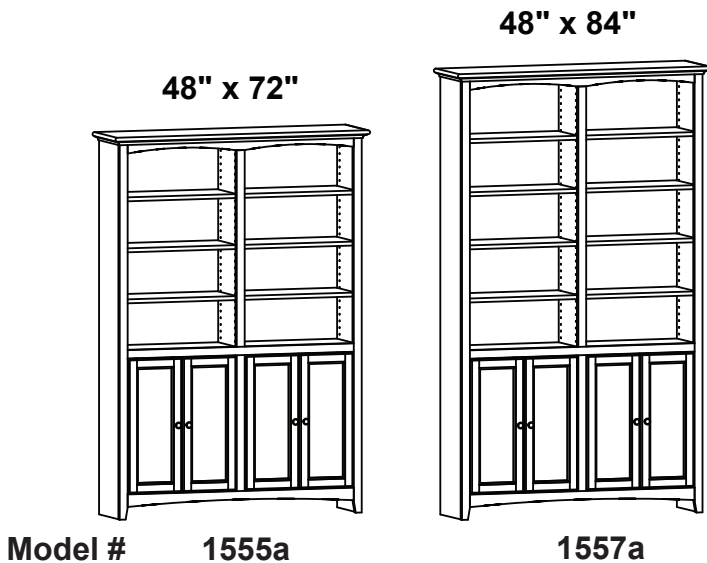

Thank you for allowing us to help you furnish your home. We are certain you will be delighted with your new furniture for many years to come.

IMPORTANT NOTES:

- This assembly requires two people.
- For normal household use only. *Not* recommended for commercial use.
- Do not climb, sit or stand on this piece of furniture.
- Do not overload the shelves.
- Unload items before you move this unit.
- Before you load or move this unit, tighten all screws and supports.
- For maximum stability, attach unit to the wall using the enclosed hardware as per instructions and supports.
- Before you begin your project, completely read the Assembly Instructions.
- Periodically inspect your furniture for any loose glue joints, screws or any other problem that might affect the stability of your furniture. Tighten or repair as needed.

WARNING

Serious or fatal crushing injuries can occur from furniture tip-over. Use of tip-over restraints may only reduce but not eliminate the risk of tip-over.

To help prevent tip-over:

- Place heaviest items in the bottom shelves.
- Unless specifically designed to accommodate, do not set TVs or other heavy objects on top of this product.
- Never allow children to climb or hang on drawers, doors or shelves.
- Never open more than one drawer at a time.

Warning: At least one tipping restraint kit was included with your piece of Whittier Wood Furniture. When you receive your furniture, be sure to find and properly install the tipping restraint(s). If you cannot locate the restraint(s), please contact us immediately for replacement.

Drilling, sawing, sanding or machining wood products can expose you to wood dust, a substance known to the state of California to cause cancer. Avoid inhaling wood dust or use a dust mask or other safeguards for personal protection.

For more information go to: www.p65warnings.ca.gov/wood

This product can expose you to chemicals, including formaldehyde, which are known to the State of California to cause cancer.

For more information go to: www.p65warnings.ca.gov/furniture

DESIGN SUBJECT TO CHANGE WITHOUT NOTICE.

CUSTOMER SERVICE

If you ever have questions about your furniture, please do not hesitate to contact us. In the unlikely event you need a replacement part; we can make those parts available through an authorized Whittier Wood Furniture dealer. If you cannot order replacement parts through your dealer, please contact our customer service department.

Hours: Our friendly customer service staff can be reached:

Monday-Friday 8:00 a.m. to 5:00 p.m. (Pacific Time).

You may leave a message 24 hours a day, seven days a week.

Customer Service: 800-653-3336 • **Outside the U.S.:** 541-687-0213

Fax: 541-687-2060 • **Email:** info@whittierwood.com

**Whittier
Wood**
FURNITURE

P.O. Box 2827
Eugene, OR 97402 USA

Production Code:

McKenzie Alder Bookcase Program — Parts List

Before you begin to assemble this unit, identify each part and make sure the quantities received match what is on this list.

If you need to replace a part, please refer to the following list for the finish, part name and letter code.

Bookcase Finish

Please note the finish of the bookcase for replacement part orders.

Bookcase finish options are subject to change.

Stain

















GAC Glazed Antique Cherry	CAF Caffè	FST Fieldstone	HAZ Hazelnut	NA Natural Alder
----------------------------------	------------------	-----------------------	---------------------	-------------------------

Paint

SN Snowbound SW 7004	AW Aged White SW 9180	SL Silverplate SW 7649	TB Tricorn Black SW 6258
-----------------------------	------------------------------	-------------------------------	---------------------------------

Two-Tone

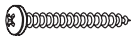
SNN Snowbound SW 7004 Natural Alder	AWN Aged White SW 9180 Natural Alder	SLN Silverplate SW 7649 Natural Alder	TBN Tricorn Black SW 6258 Natural Alder
--	---	--	--

Part	Description	Image	Quantity (by Model #)	
			1555a	1557a
A	Adjustable Shelf (attached)		8	10
B	Shelf Bracket (inserted)		32	40
C	#6 x 1/2" Undercut Screw (inserted)		32	40
D	Top Assembly (attached)		1	
G	#8 x 1" Pan Head Screw (inserted)		10	
H	Nylon Insert (inserted)		4	
I	Small Adjustable Glide (installed)		4	
J	Door (installed)		4	
K	Interior Hinge (attached)		4	
L	1/4" Stainless Washer (attached)		8	
M	Knob (installed)		4	
Na	#8 x 1-1/2" Machine Screw Tuscan (installed)		4	
O	Exterior Hinge (attached)		4	
P	Base Plate (attached)		8	
Q	#8 x 1-1/4" Pan Head Screw (inserted)		30	
R	#8 x 1-5/8" Black Screw (inserted)		3	
TB	Bookcase Tipping Restraint (attached)		1	

McKenzie Alder Bookcase with Doors

Assembly Instructions

Tools Required: Phillips Screwdriver, Pencil, Rubber Mallet or Padded Hammer

Fig. 1
1555 Shown

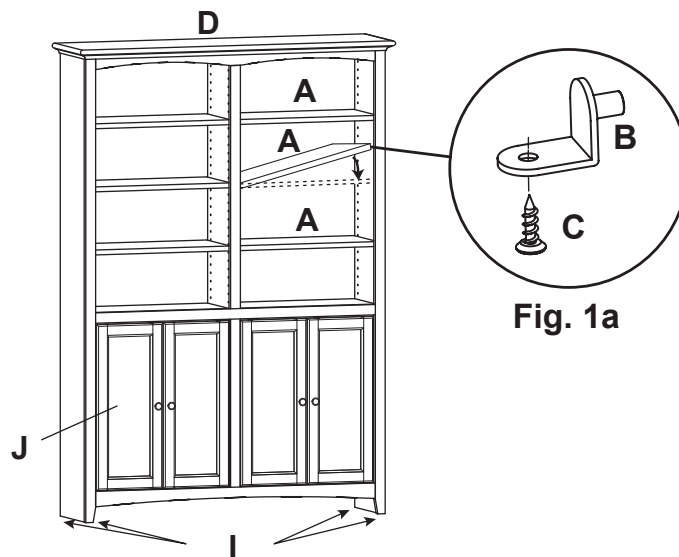

To move the adjustable shelves:

1. Determine where you want to place the Adjustable Shelves (A). Remove the #6 x 1/2" Undercut Screws (C) from the underside of the shelf and take out the Shelf and Shelf Brackets (B). Insert the Shelf Brackets (flat side down) into the four different holes and insert the shelf. You may secure them by inserting #6 x 1/2" Undercut Screws (C). See Figure 1a.
2. The door may need to be adjusted so that all the spaces between the doors and unit sides are equal. To make those adjustments, follow the instructions in Figure 2.

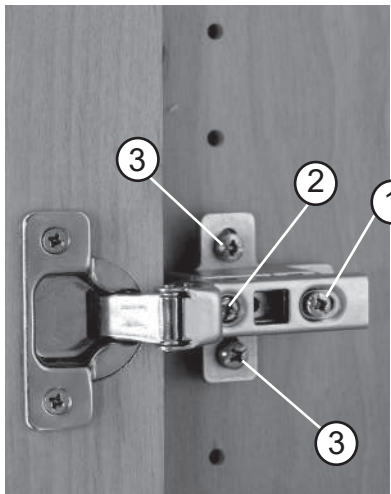

Fig. 2

Side adjustment

To move the door towards the side panel, rotate screw '2' counter-clockwise. To move it away, rotate screw '2' clockwise.

Depth Adjustment

Loosen screw '1' and adjust door. Re-tighten screw.

Height Adjustment

Loosen screws '3' and adjust door. Re-tighten screw.

If there is a problem with a Hinge (K), do not attempt to remove it. Contact Customer Service first.







3. Place the bookcase at your desired location. Level the unit using the Adjustable Glides (I) located on the bottom of the unit. See Figure 1.

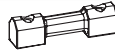

Continued on Page 4

Bookcase Tipping Restraint Instructions

Before you begin this assembly, identify each part and make sure the quantities received match what is on this list. If you need to replace a part, contact Whittier Wood Furniture customer service and refer to the following list for its name and letter code.

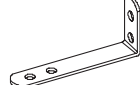
Part	Description		Quantity
A	Cam Buckle and Short Strap (installed)		1
B	Plastic Bracket (installed)		1
C	1" x 1000mm Long Strap (installed)		1
D	#8 x 3" Pan Head Screw		2
F	Washer (installed)		1
G	#8 x 5/8" Pan Head Screw		2 (1 inserted)
H	#8 x 1-1/4" Pan Head Screw		1
I	"L" Angle Bracket		1

If you have a stone or tile floor or do not wish to drive screws into the corner of the baseboard and floor see the instruction included inside the tipping restraint kit for an alternate installation.

- Decide where you want to place the bookcase in your room. Mark the baseboard with a pencil mark directly behind the location where the tipping restraint is attached to your item. Move the item away from the wall far enough to allow you to access the spot where the baseboard meets the floor. Position the straps and Plastic Bracket (B) as shown in Figures 4 and 4a with the angled corners of the Plastic Bracket (B) firmly placed against the seam of the baseboard and floor. Attach by driving #8 x 3" Pan Head Screws (D) through the holes in the Plastic Bracket (B) into the seam below the baseboard where it meets the floor. See Figures 4 and 4a.

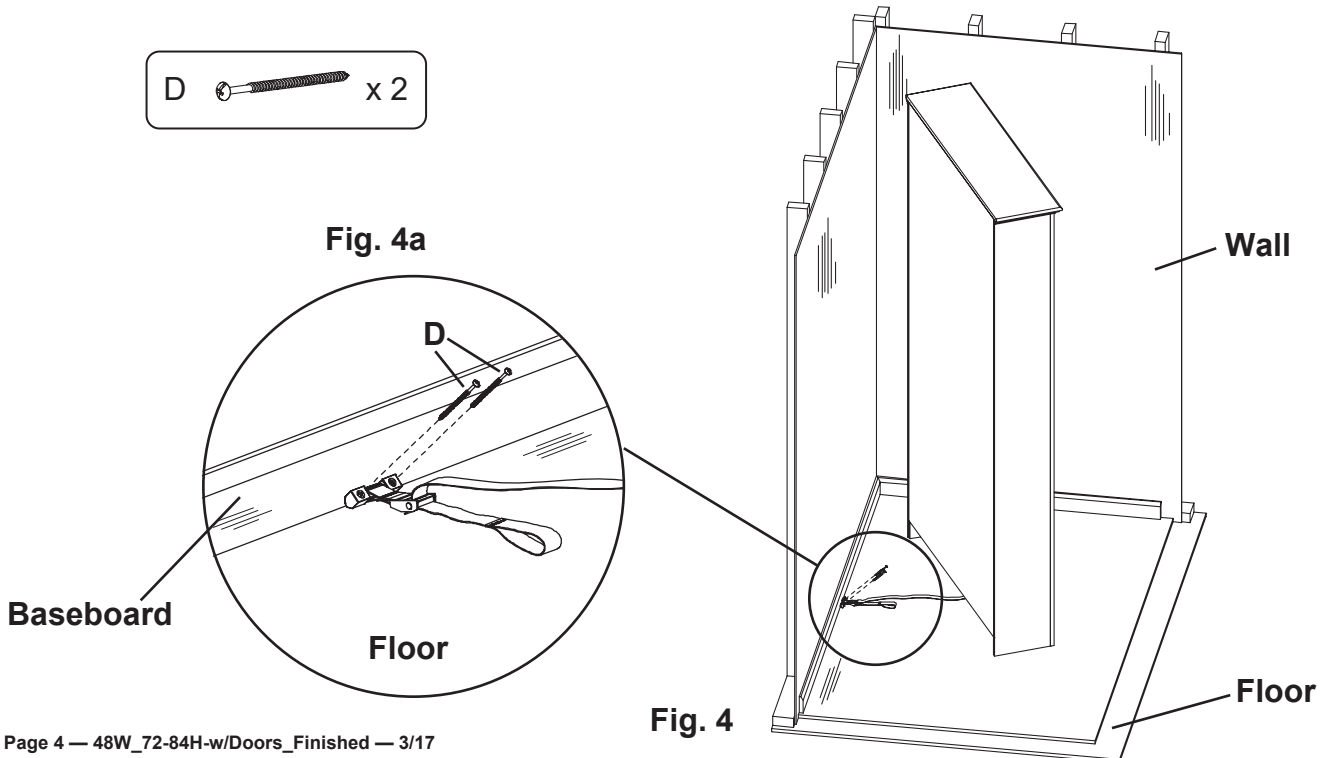

5. Move the item back into position against the wall and reach underneath the bookcase to grasp the loop in the free end of the strap. Pull the free end of the strap until portion between the Cam Buckle (A) and the bottom of the item is tight. See Figures 5 and 5a. If you need to move the bookcase reach beneath and locate the buckle which connects the two sections of the strap and depress the release lever, then pull on the section of strap that is between the buckle and the bottom of the furniture until there is enough slack to allow you to pull the item away from the wall.

