

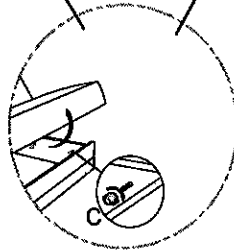

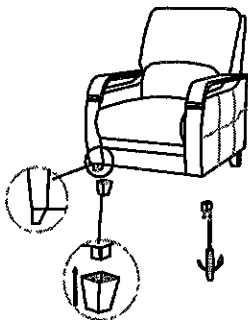

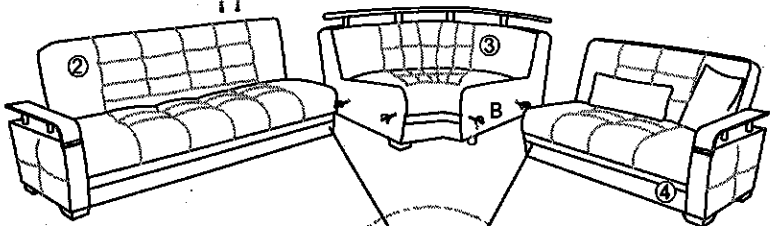

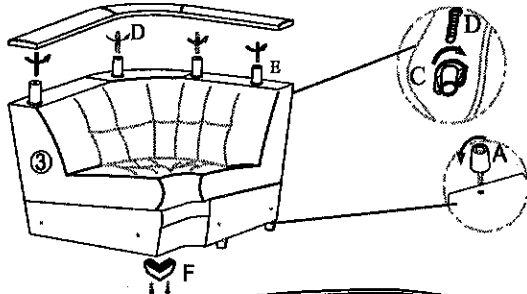
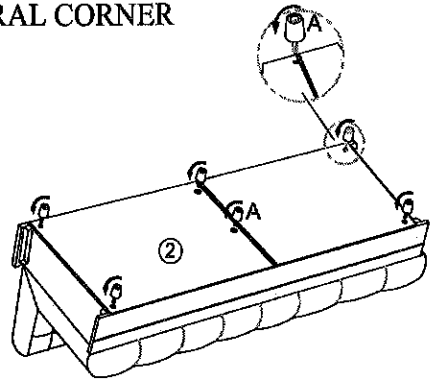
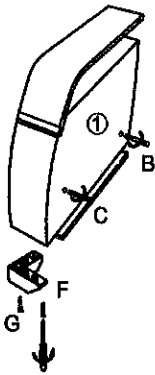

# NATURAL CORNER



- |   |       |
|---|-------|
|  | A x13 |
|  | B x8  |
|  | C x12 |
|  | D x4  |
|  | E x4  |
|  | F x5  |
|  | G x10 |

