

1A Parts in Box 1 / Pièces dans la boîte 1

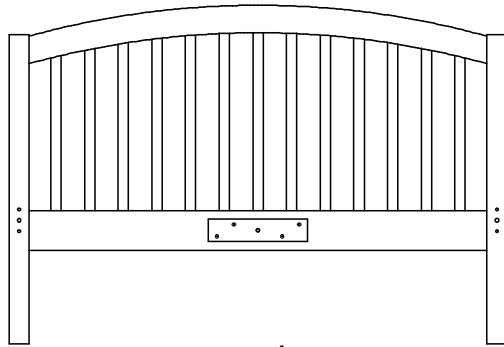

Headboard / Tête de lit **x 1**

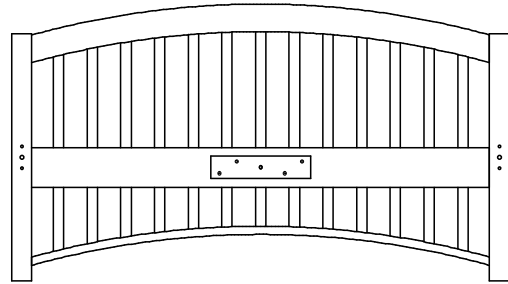

Footboard / Pied de lit **x 1**

1B Parts in Box 2 /
Pièces dans la boîte 2

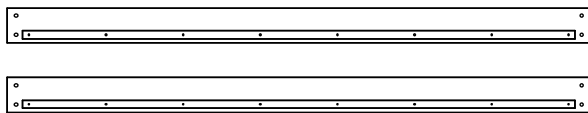

Rails / Rails **x 2**

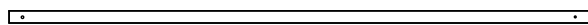

Center Rail / Rail du centre **x 1**

1C Parts in Box 3 /
Pièces dans la boîte 3

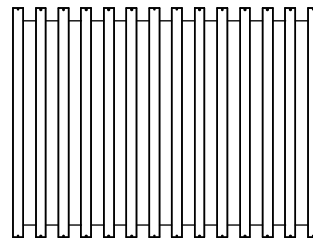

Set of Slats / Ensemble de lattes **x 1**

1D Hardware in this box. / Quincaillerie incluse.



100mm Bolts /
Vis (100mm) **x 8**

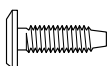

15mm Bolt /
Vis (15mm) **x 4**

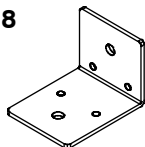

Center Rail Bracket /
Crochet du rail du centre **x 2**



35mm Bolt /
Vis (35mm) **x 8**



Barrel Nut /
Écrous **x 8**

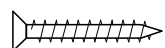

25mm Wood Screws /
Vis à bois (25mm) **x 20**

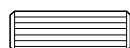

Wooden Dowels /
Goujons de bois **x 4**



Long Allen Key /
Longue clef allen **x 1**

Please Note: Do not assemble using power tools. This can cause the bolts to be overtightened

A Noter: Ne pas assemblé avec de l'outillage à puissance. Cela peut causer les boulons à être trop serré.



1E Fit Wood Dowels to the Rail. /
Adjuster les goujons au rail.

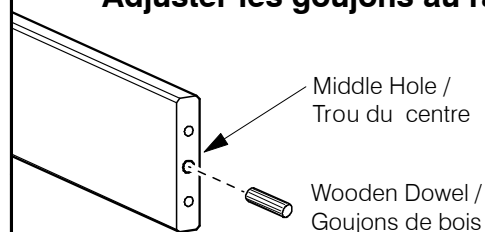

Middle Hole /
Trou du centre

Wooden Dowel /
Goujons de bois

Tap the Wooden Dowel all the way into the Middle hole at the ends of the Rails. / Taper les goujons jusqu'au fond dans les trous du centre situés à chaque bout des rails.

**2A Fit the Metal Bracket to the Headboard and Footboard. /
Ajuster le crochet de métal à la tête et au pied de lit.**

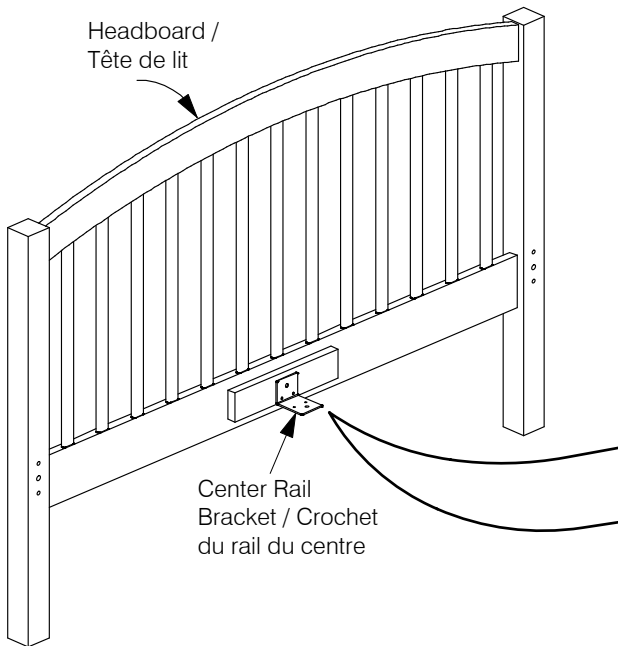

Use 15mm Bolt to fix the Center Rail Brackets to the inside of the Headboard & Footboard. Tighten the Bolts fully. / Utiliser les vis 15mm pour fixer les crochets du rail du centre sur le côté de la tête et du pied de lit. Serrer fermement les vis.

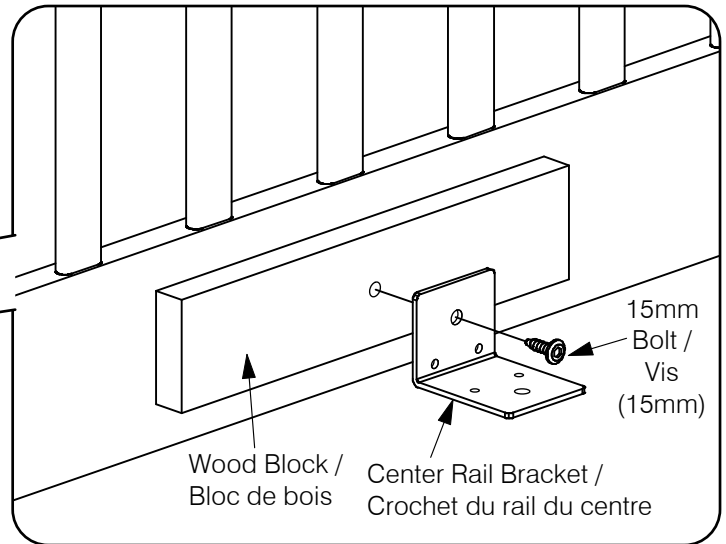

2B Attach the Rails to the Headboard and Footboard. / Attacher les rails à la tête et au pied du lit.

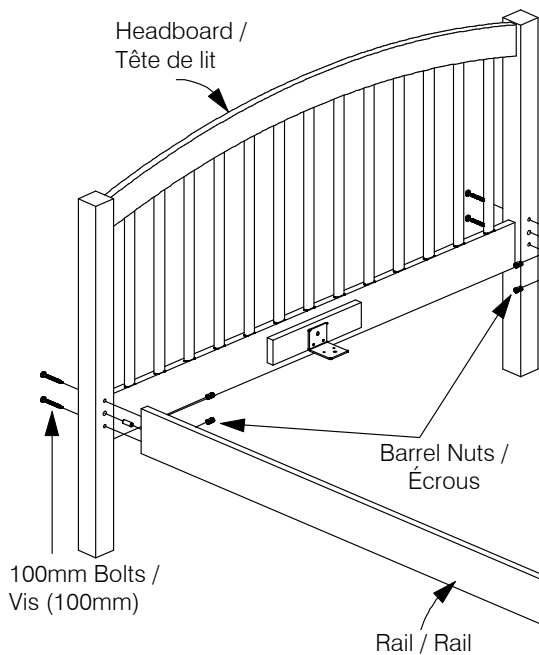

✓ Leave the Bolts a bit loose, so it is easier to align the slats. Only after everything is put together should you tighten all the Bolts. / Laisser les vis un peu lâche pour faciliter l'alignement des lattes. Une fois le tout mis en place serrer toutes les vis.

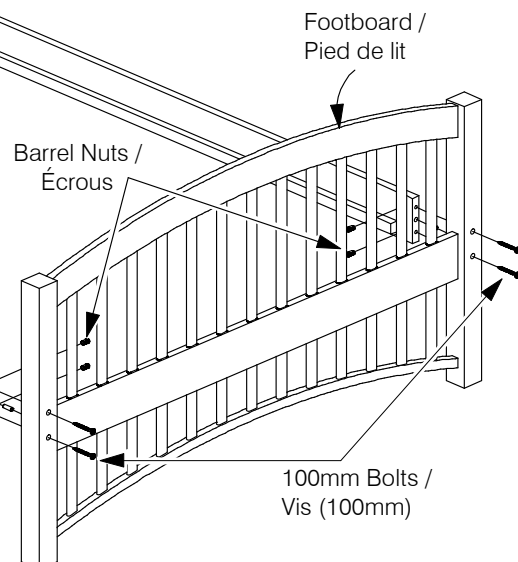

3A Fit the Center Rail. / Mettre le rail du centre.

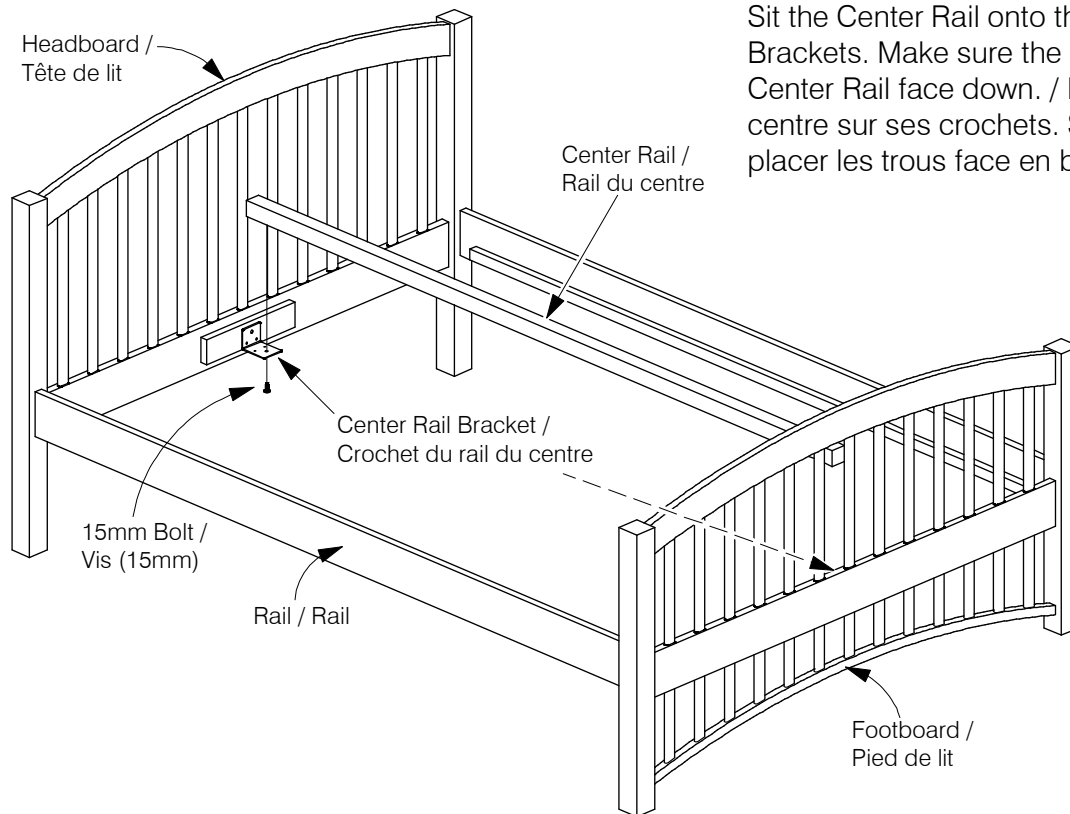

Sit the Center Rail onto the Center Rail Brackets. Make sure the holes in the Center Rail face down. / Placer le rail du centre sur ses crochets. S'assurer de placer les trous face en bas.

3B Fix the Slats in place. / Mettre les lattes en place.

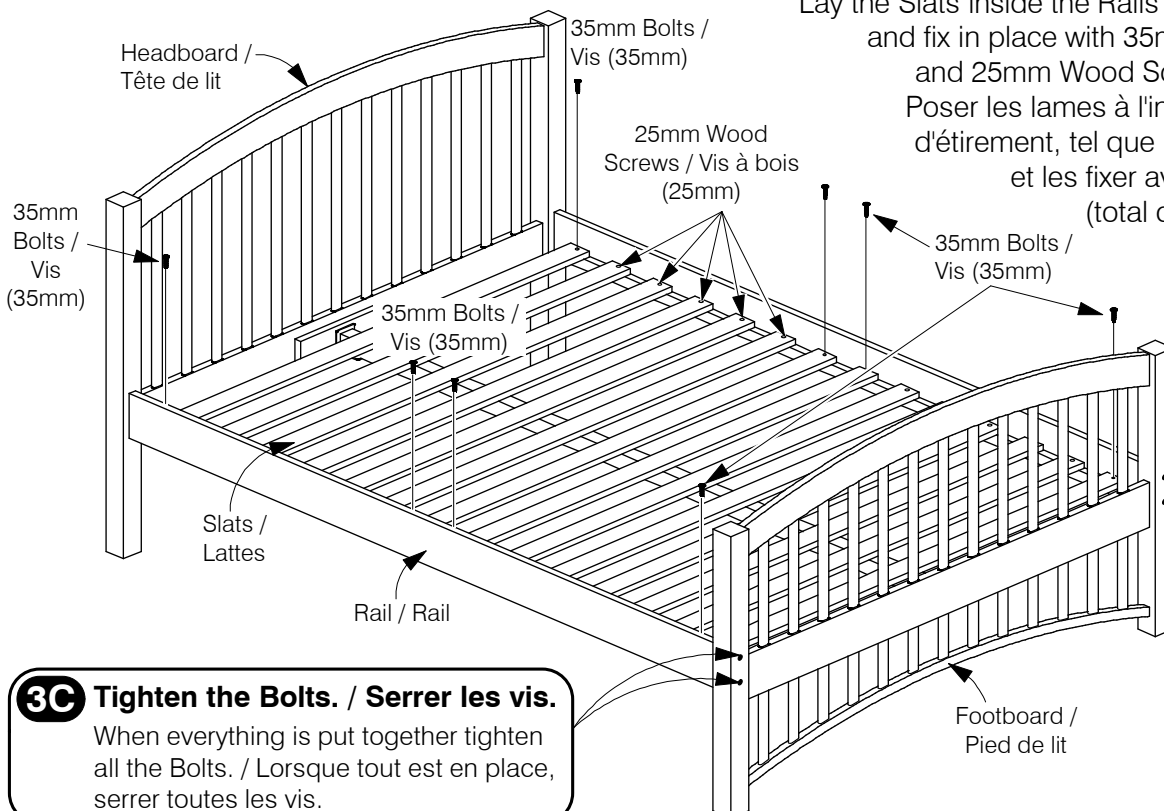

Lay the Slats inside the Rails as shown below, and fix in place with 35mm Bolts (total 8) and 25mm Wood Screws (total 20). / Poser les lattes à l'intérieur des rails d'étirement, tel que montré ci-contre, et les fixer avec les vis 35mm (total de 8) et les vis de bois de 25mm (total de 20).

3C Tighten the Bolts. / Serrer les vis.

When everything is put together tighten all the Bolts. / Lorsque tout est en place, serrer toutes les vis.