

**W** Walker  
**E** Edison  
furniture company

Item #: C38B5  
Assembly Instructions

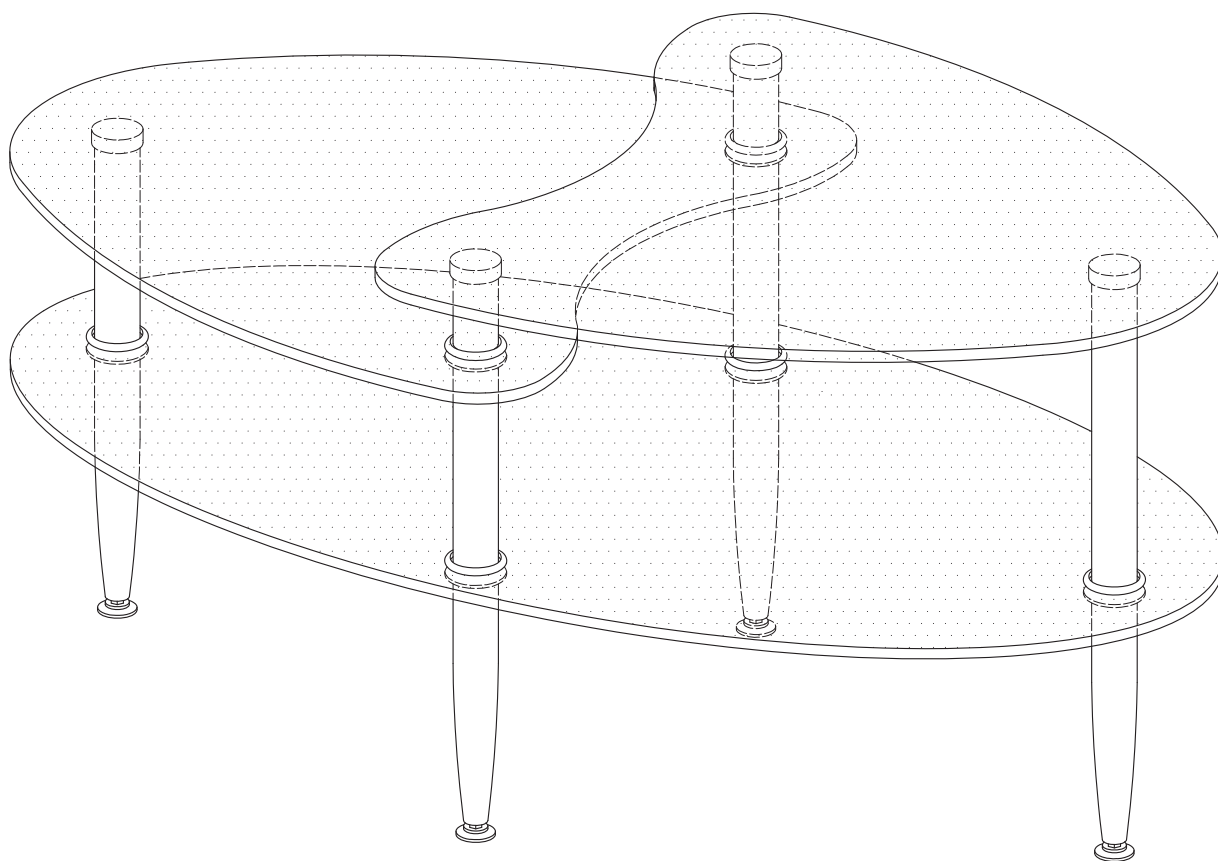



*For our most current instructions, to request missing, lost or broken parts, or for any other Customer Service issues, please visit our website at [www.walkeredison.com](http://www.walkeredison.com) or call us at 877-207-5906.*

Revised 092010

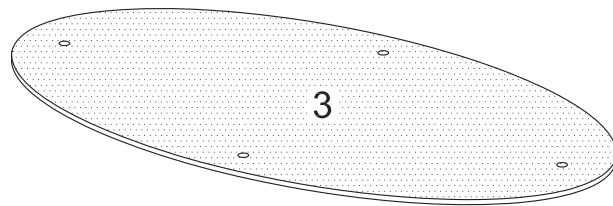
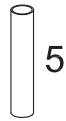
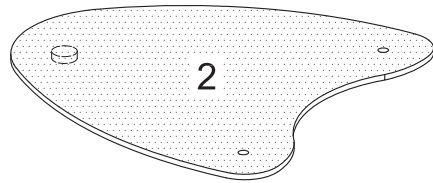
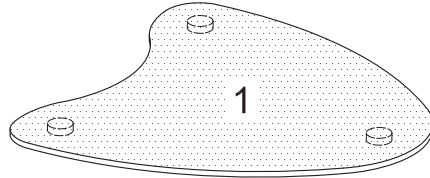
# Parts List



# Hardware List

A		M8 x 260mm	Long rod	3 pcs
B		M8 x 180mm	Short rod	1 pc
C			Decorative ring	12 pcs

*The hardware quantities listed above are required for proper assembly. Some extra hardware may also have been included.*

# Step 1

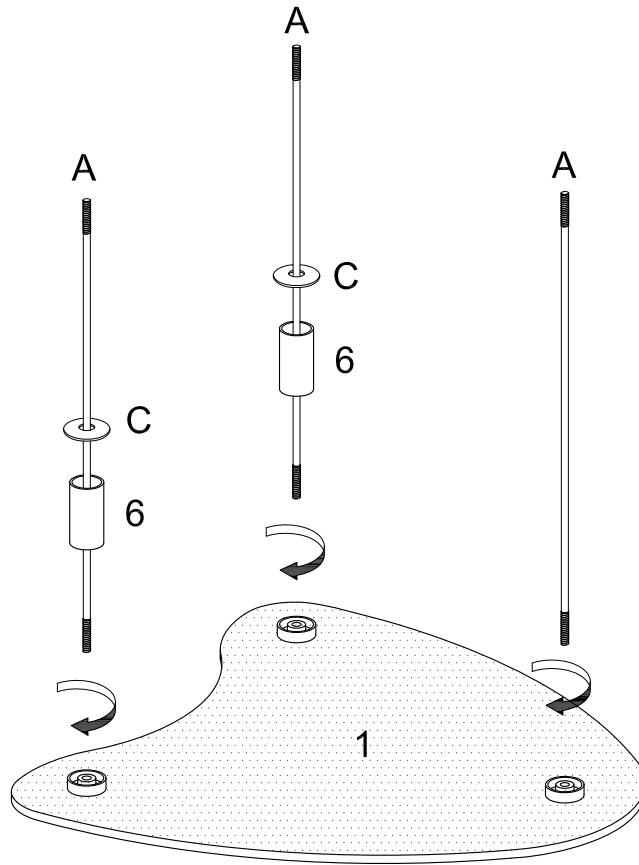

Carefully lay top glass (1) up-side-down on a soft surface. Screw long rods (A) into the plates of top glass (1). Slide cylinders (5) and decorative rings (C) onto middle long rods (A). Snap decorative rings (C) onto cylinders (6).

# Step 2

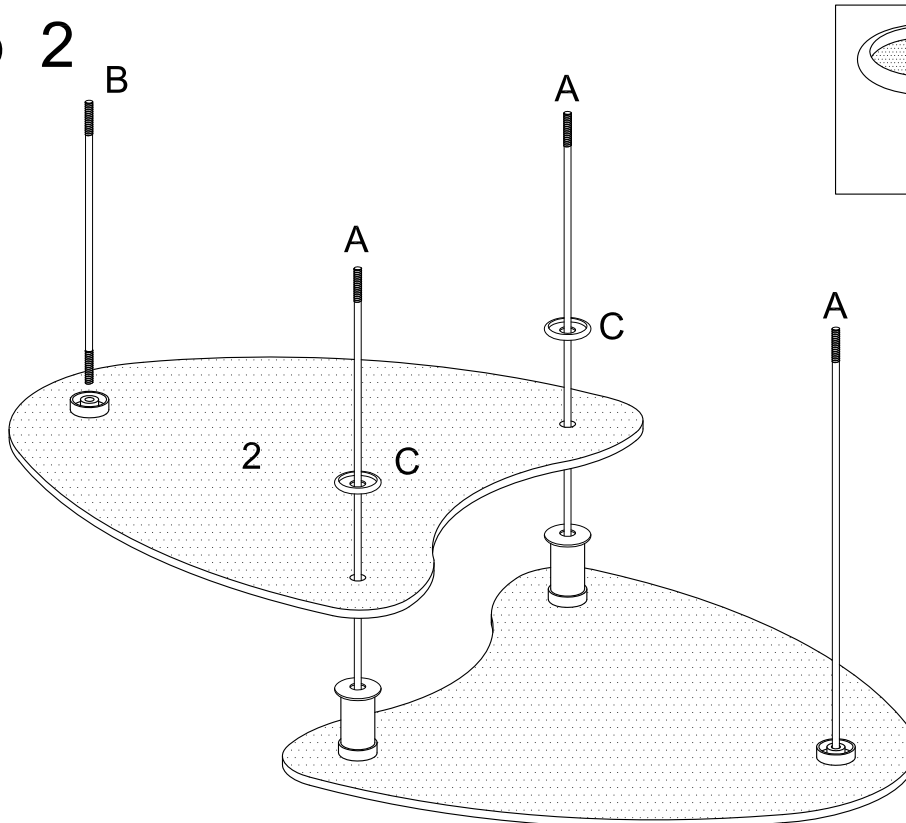

Slide top glass (2) then decorative rings (C) onto middle rods (A). Screw short rod (B) into the open plate of top glass (2).

## Step 3

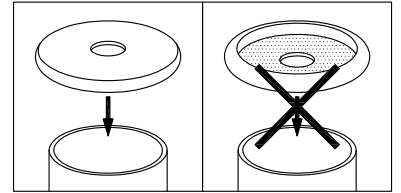
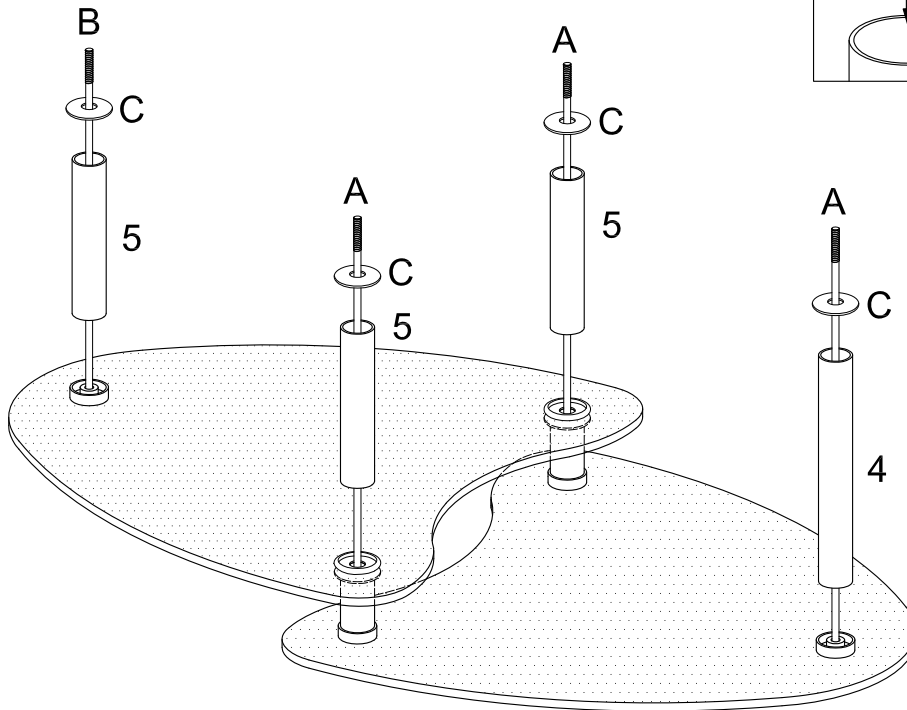

Slide cylinder (4) onto right long rod (A). Slide cylinders (5) onto middle long rods (A) and short rod (B). Slide decorative rings (C) onto all rods (A,B). Snap decorative rings (C) onto cylinders (4,5).

## Step 4

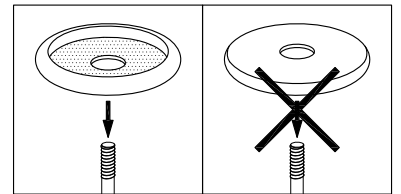
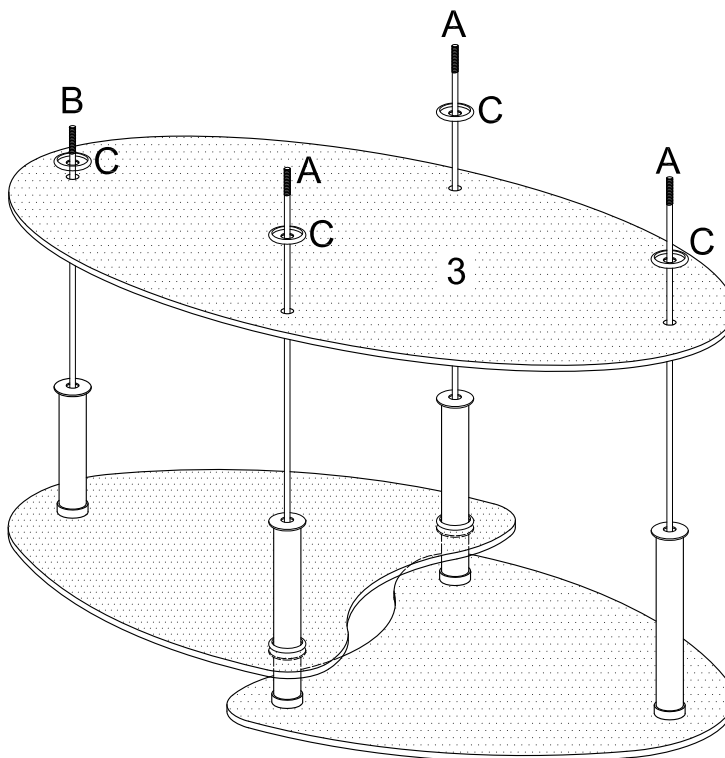

Carefully slide bottom glass (3) then decorative rings (C) onto all rods (A,B).

## Step 5

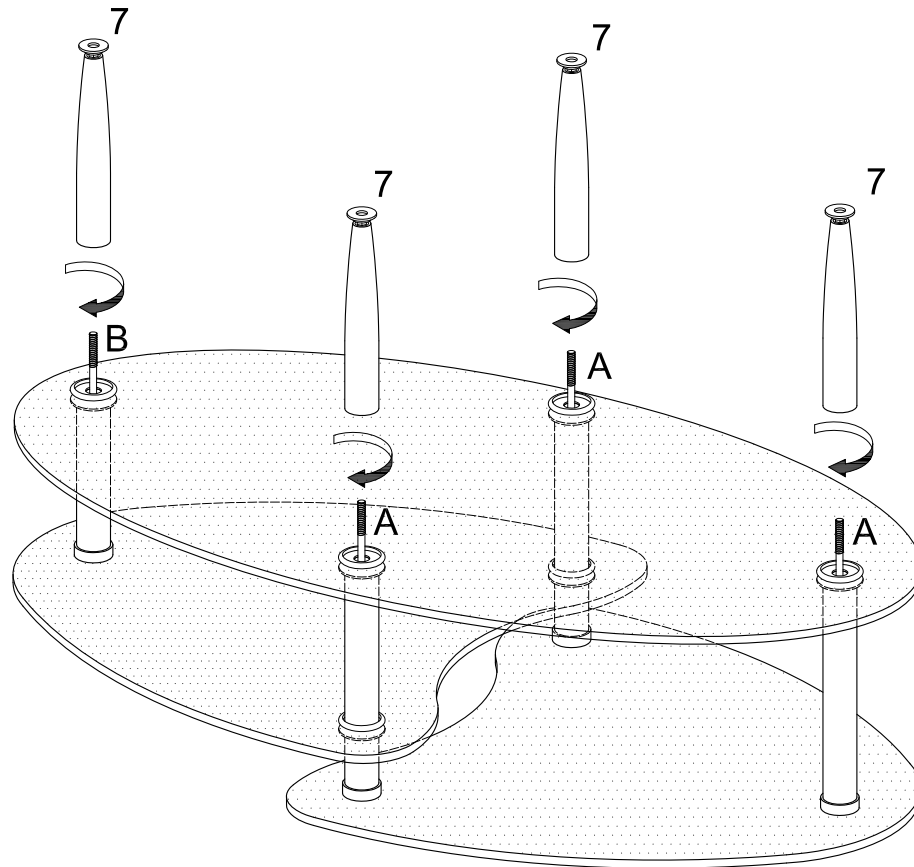

Screw legs (7) onto all rods (A,B). *Ensure that legs (7) fit snugly into the decorative rings placed in the previous step.*

## Step 6

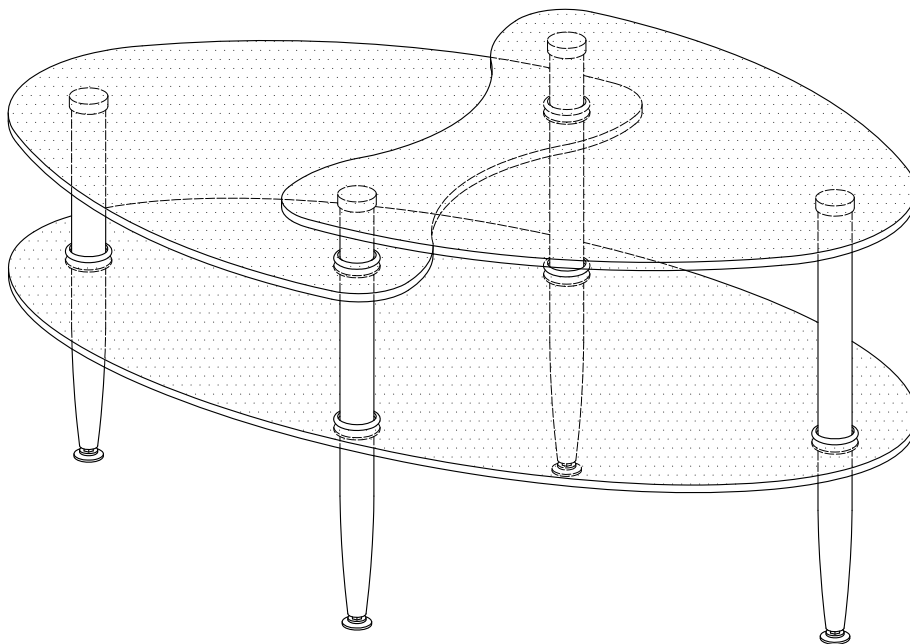

Final Assembly